

**Distribuidor
Revenda
Consertos**

Danfoss

HMC

hydraulics

www.hmc.com.br

(11) 4174-3300

Productivity and performance

The PLUS+1[®] control platform

Smart

control systems

bring your machines
faster, more
efficiently to market.

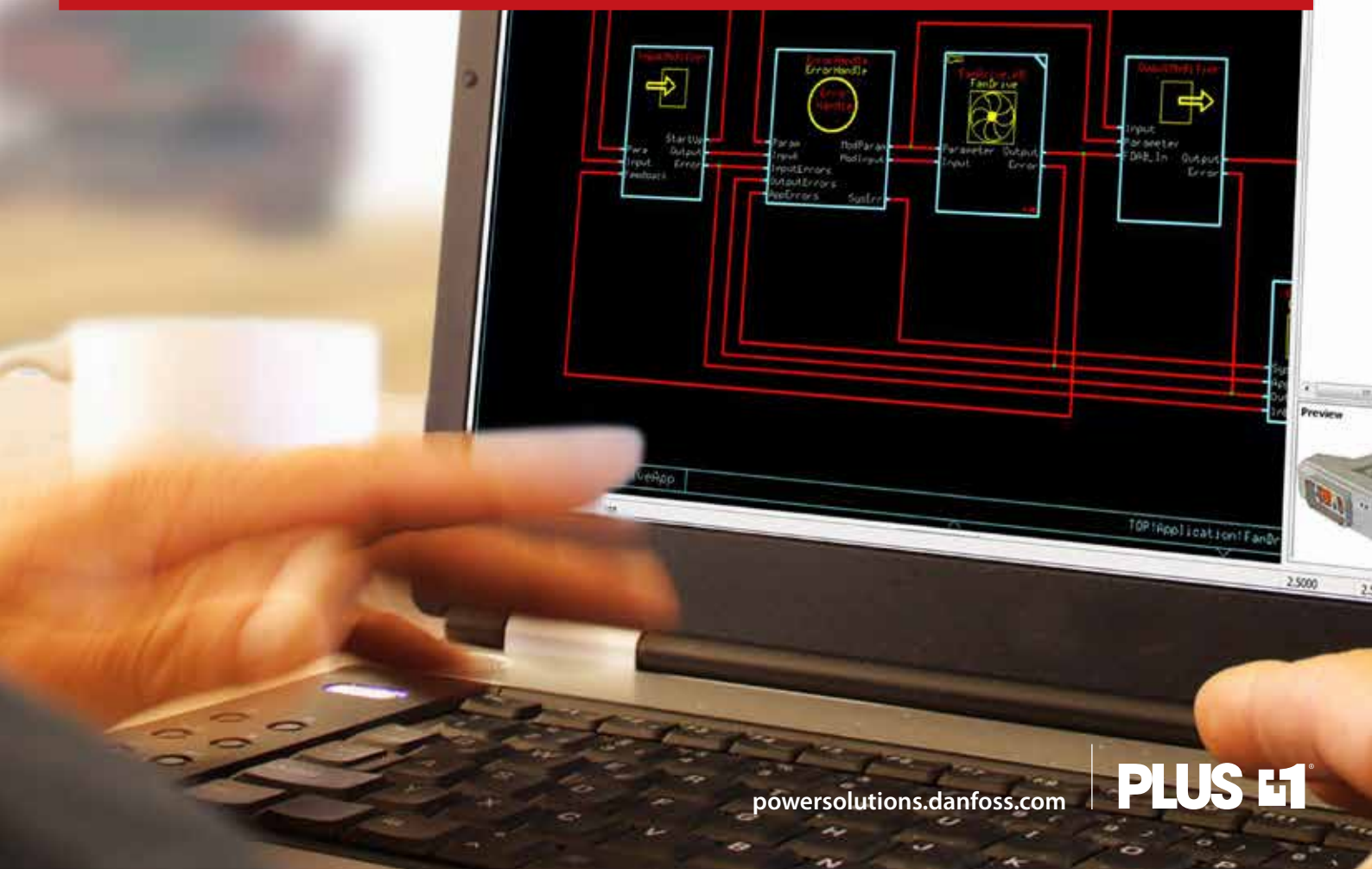

Taking mobile machine control to the next level

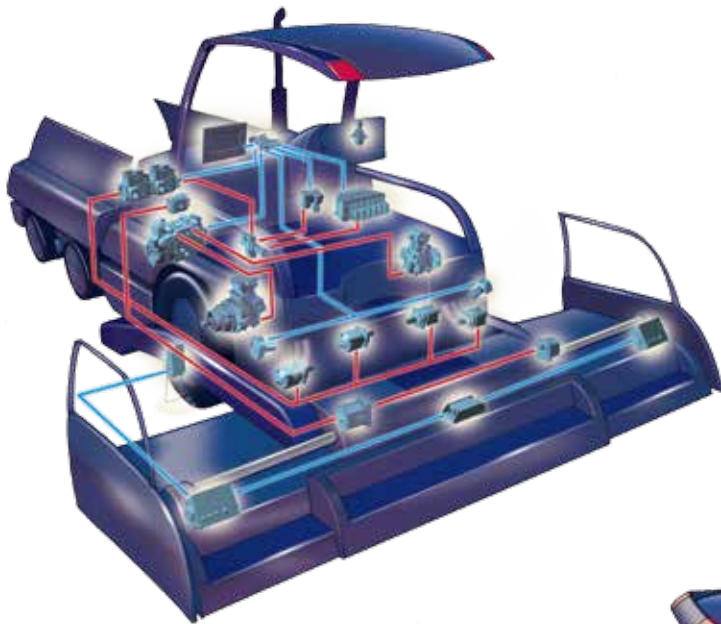

The OEM design environment continues to become more challenging, every day, every year. Vehicle design teams are expected to accomplish more with fewer resources, while meeting the demands of tighter emission and safety regulations.

Danfoss has a powerful, proven solution for today's challenges: PLUS+1®, a complete development environment for machine control solutions. With the combined powers of PLUS+1 technology, the PLUS+1 GUIDE software platform, and a growing portfolio of PLUS+1 Compliant products, you are able to rapidly develop and customize electronic machine control. PLUS+1 provides a new level of freedom for design engineers, all while reducing coding time and testing.

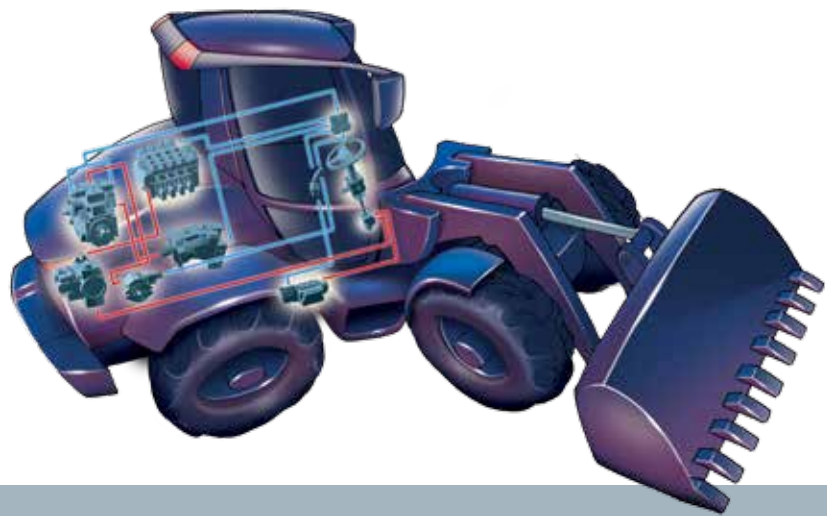

The PLUS+1® advantage: bring better machines to market faster

With the PLUS+1 platform, you can quickly build customized applications from the Danfoss library of software control components, and reduce the cost and development time normally associated with programming.

PLUS+1's modular design of hardware and software allows developers to effectively construct a solution that easily scales to the machine's control requirements. Developers use this flexibility to add value and machine differentiating features at the level of complexity that fits the design challenge.



45 years of experience at your disposal

The PLUS+1® Control Platform offers more than just today's cutting edge technology for mobile machine control – with PLUS+1 comes decades of collective vehicle application experience. Our proud history is firmly rooted in hydraulics and fluid power, coupled with vast and ever-evolving know-how in electronics, steering components, and spool valves. Danfoss brings all of this knowledge into PLUS+1.

OEMs can use this world-class operational core and knowledge as a foundation for their next generation of mobile off-highway vehicles. Even better, users can build on this foundation with their own creativity to further differentiate vehicle systems.

Your strongest partner in machine control design

At Danfoss, our whole team supports your machine: from software engineers to system specialists and vehicle application experts. Taking a truly integrated systems approach has helped Danfoss become known for exceptionally strong customer and system support around the globe.

We make it our business to have an in-depth understanding of system functionality, application requirements, and market demands in different parts of the world. We want to know your machinery needs and to serve them better than anyone else.



The PLUS+1[®] family of microcontrollers

Danfoss' broad portfolio of PLUS+1[®] microcontrollers are the 'central command' of any PLUS+1 system, and they are developed with your need for robustness and flexibility in mind. Our PLUS+1 microcontrollers offer many software-configurable hardware features making it easy to match the input and output requirements of your application. Some modules even include high-output current capabilities for other electrical system elements, such as lighting, small DC electric motors, and high-current solenoids.

Our powerful PLUS+1 microcontrollers are equally suited to bring intelligence to every node of a distributed control system, or act as a stand alone control solution for applications that are smaller in scope. And thanks to their rugged design, they'll withstand the toughest conditions your vehicle can encounter. PLUS+1 controllers combine state-of-the-art electronics and robust packaging to ensure your solution delivers high performance with reliability you can trust.

Features & benefits:

- High-speed DSP (Digital Signal Processor) technology to process even the most complex applications
- Stackable microcontrollers for high mounting flexibility
- CAN-based communications for state-of-the-art control performance
- 8 I/O configurations (14 include I/O modules) for multiple control options – the building blocks for almost every function



More information

Available online

Interested in more PLUS+1 features, including components, licensing, downloads, support, online training, and the PLUS+1 Help Desk?

Dig deeper at

www.powersolutions.danfoss.com/PLUS1

PLUS+1

Robust, intelligent, and totally customizable

PLUS+1[®] microcontrollers

Product family	Rated current	Inputs*				Outputs*			Optional features	
		Timing	Digital	Analog	Rheostat	PWM (3A max)	PVG	Digital (3A max)	Application keyed	Other
MC012-01x	8A	3	3	4	-	2	2	2	Yes	High temp
MC024-01x	8A	5	11	8	2	3	3	3	Yes	+ Memory
MC024-02x	24A	5	7	6	-	8	8	8	Yes	+ Memory
MC038-01x	70A	3	14	13	-	8**	-	13**	Yes	-
MC050-01x	40A	6	12	12	4	6	6	12	Yes	+ Memory
MC050-02x	40A	6	20	14	2	6	6	14	Yes	+ Memory
MC050-05x	8A	4	33	36	-	2	2	3	Yes	ISOBUS
MC088-01x	100A	6	32	24	8	32**	10	10	Yes	-

* Maximum number available through multi-function configurability

** High current outputs available

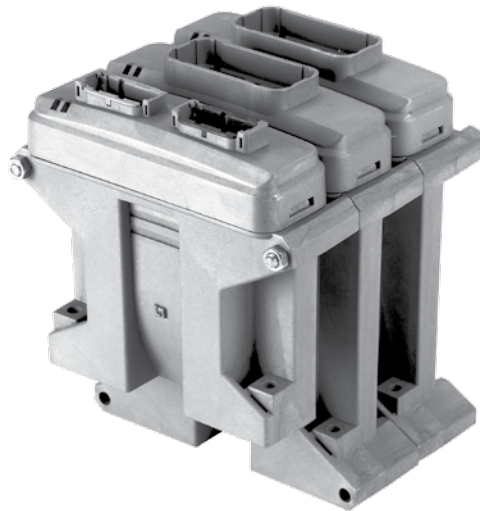

PLUS+1

PLUS+1 input/output (I/O) modules

Designed to extend the functionality of the PLUS+1[®] microcontrollers, our I/O modules can be configured to match your exact input and output requirements, and are used as the building blocks for almost any control function. These stackable microcontroller add-ons integrate new control functions smoothly and effectively.

Product family	Rated current	Inputs*				Outputs*		
		Timing	Digital	Analog	Rheostat	PWM (3A max)	PVG	Digital (3A max)
IX012-010	-	3	3	6	2	-	-	-
OX012-010	16A	-	-	-	-	6	6	6
IOX012-010	8A	3	3	4	-	2	2	2
IX024-010	-	7	13	12	4	-	-	-
OX024-010	32A	-	-	-	-	10	10	16
IOX024-20	24A	5	7	6	-	8	8	-

* Maximum number available through multi-function configurability

Benefits of GUIDE include:

- Graphical development environment for easy to understand coding
- Flexible design environment
- Simplified code reuse for decreased time to market
- Quickly create custom solutions
- Complete integration with PLUS+1 Compliant products
- Application blocks backed by years of experience
- User friendly PC-based service tool

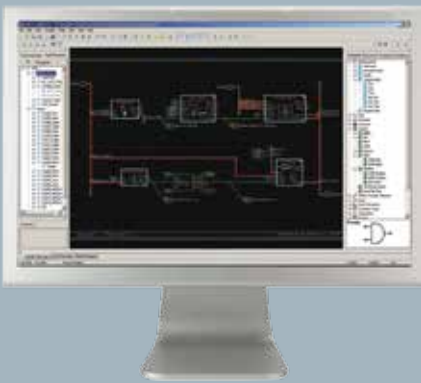

Scalable software solutions at your fingertips

GUIDE – Graphical User Integrated Development Environment

Time-to-market is crucial in the mobile machinery industry, and PLUS+1® GUIDE provides a powerful, proven software framework to quickly build – and customize – complete electrohydraulic sub-system and vehicle control solutions. With GUIDE, you can easily and efficiently integrate control, work and propel functions for superior mobile machinery control.

GUIDE provides a graphical-based approach to programming PLUS+1 devices. Its drag-and-drop platform reduces the cost and development time normally associated with programming. GUIDE also includes system diagnostic tools, downloading utilities and customizable service interfaces. With GUIDE, you'll have the power to create well differentiated, custom solutions to help you bring better machines to market faster.

Maximize machine performance

It's your choice. With GUIDE, you can choose the appropriate level of software based on the functionality and development complexity you desire. GUIDE is an ever-expanding set of building blocks that allows you to choose everything from basic components to operation-ready solutions. All of these are expertly designed to help you maximize machine performance.

Using GUIDE, control system developers draw from a hierarchy of pre-tested software blocks or modules that can be reliably integrated at all levels. Once you select an application block, it can be immediately compiled and downloaded to the controller – if it's a perfect fit to vehicle requirements. Or, it can be tailored to specific vehicle requirements by reprogramming within the GUIDE environment.

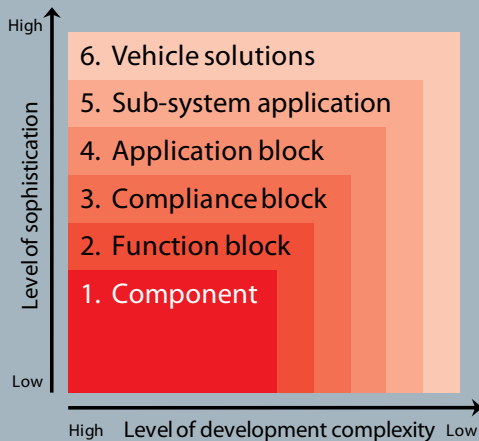

Level	Application block	Function
6	Vehicle solutions	Provides customizable, operation-ready solutions for CAN bus-networked and multiple sub-systems
5	Sub-system application	Builds on core application blocks to provide complete "ready to go" solutions.
4	Application block	Provides core logic for control of propulsion, steering and work functions
3	Compliance block	Eases the task of integrating input and output devices, such as sensors, joysticks and controls for pumps, motors and valves
2	Function block	Performs higher level tasks such as filtering and ramping
1	Component	Provides the basic blocks for CAN messages, arrays, math and logic functions

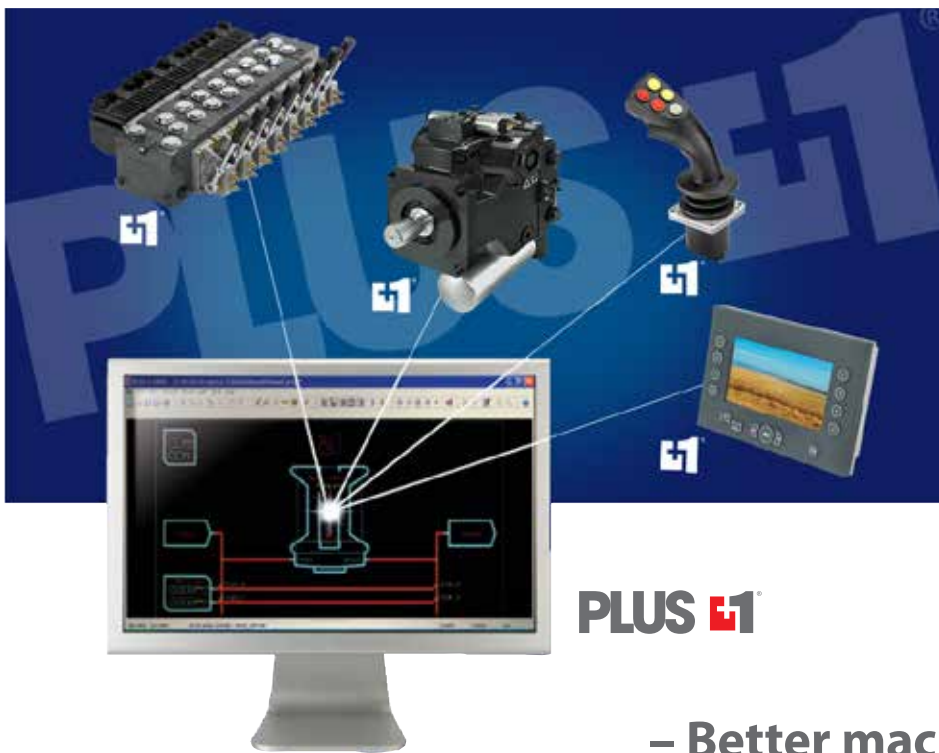

Look for the
PLUS+1® Compliant
Icon on all Your System
Components



PLUS+1

– Better machines to market faster

PLUS+1 Compliance brings it all together

PLUS+1® Compliance ties our advanced mobile control technology together – ensuring all our electrohydraulic products integrate seamlessly in the customized control system developed using PLUS+1 GUIDE.

Using PLUS+1 Compliant products within the GUIDE programming environment means that you can develop customized controls faster than ever before. You can be certain a product with the PLUS+1

Compliant Icon has been tested with other PLUS+1 Compliant products and GUIDE Compliance Block software modules, assuring optimum performance and seamless integration.

A comprehensive PLUS+1 product portfolio

Danfoss has taken even more guesswork out of your design process by creating an extensive line of PLUS+1 Compliant products. Together with the GUIDE

development platform, Compliant products are developed with design engineers in mind. Development and testing time is reduced, all while maximizing machine performance.

With PLUS+1 Compliant components, you can be confident in the design system validation process - and bring your machines to market faster.



About Danfoss Power Solutions

Danfoss Power Solutions is a global manufacturer and supplier of high-quality hydraulic and electronic components. We specialize in providing state-of-the-art technology and solutions that excel in the harsh operating conditions of the mobile off-highway market. Building on our extensive applications expertise, we work closely with you to ensure exceptional performance for a broad range of off-highway vehicles. We help OEMs around the world speed up system development, reduce costs and bring vehicles to market faster.

Danfoss Power Solutions – your strongest partner in mobile hydraulics.

Products we offer:

- Bent Axis Motors
- Closed Circuit Axial Piston Pumps and Motors
- Displays
- Electrohydraulic Power Steering
- Electrohydraulics
- Hydraulic Power Steering
- Integrated Systems
- Joysticks and Control Handles
- Microcontrollers and Software
- Open Circuit Axial Piston Pumps
- Orbital Motors
- PLUS+1® GUIDE
- Proportional Valves
- Sensors
- Steering
- Transit Mixer Drives

Wherever off-highway vehicles are at work, so is Danfoss Power Solutions. We offer you expert worldwide support for ensuring the best possible solutions for outstanding performance. And with an extensive network of Global Service Partners, we also provide you with comprehensive global service for all of our components.

Go to www.powersolutions.danfoss.com for further product information.

Danfoss Power Solutions (US) Company

2800 East 13th Street
Ames, IA 50010, USA
Phone: +1 515 239 6000

Danfoss Power Solutions ApS

Nordborgvej 81
DK-6430 Nordborg, Denmark
Phone: +45 7488 2222

Danfoss Power Solutions GmbH & Co. OHG

Krokamp 35
D-24539 Neumünster, Germany
Phone: +49 4321 871 0

Danfoss Power Solutions Trading (Shanghai) Co. Ltd.

Building #22, No. 1000 Jin Hai Rd
Jin Qiao, Pudong New District
Shanghai, China 201206
Phone: +86 21 3418 5200